

Choice - Six support sizes to choose from with matching Speaker Range to truly integrate your Hi-Fi and AV in your home.

Elegance - Solid kiln-dried ash hardwood - Natural Ash, Natural Cherry, Mahogany, Walnut and Black Ash finishes.

Flexibility - Shelves adjustable to 25mm. 6mm shelves support 250Kg & 10mm 500kgs even load. Adjustable M8 spikes.

Upgradeability - A range of upgrades are available to enhance audio & video performance. Top cappings can be replaced with flush fittings if required to allow larger displays to be accommodated.

Experience - With more than 20 years within the Hi-Fi industry Stands Unique has a reliable, proven reputation for innovation and quality. Established 1990.

All prices shown in U.K. Pounds Suggested Retail & include VAT @ 20% all dimensions are in millimetres (typical 42" Television weighs 30Kgs)

6mm Supports



6mm polished clear safety glass toughened to BS6206A Natural Cherry finish shown.

6mm Cabinets



4 / 5mm clear or grey glass sides & doors mahogany finish shown.

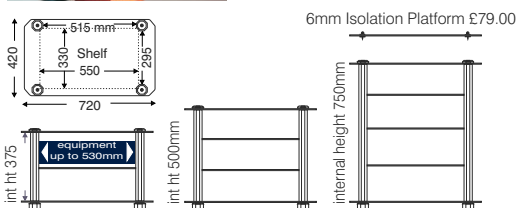

TV Support (hwd 440 x 720 x 420)

Sound Support (hwd 565 x 720 x 420)

Sound Tower (hwd 815 x 720 x 420)

TV Support Cabinet (hwd 440 x 720 x 420)

Sound Support Cabinet (hwd 565 x 720 x 420)

Sound Tower Cabinet (hwd 815 x 720 x 420)

Additional Shelf (full size) (hwd 6 x 550 x 330)

Isolation Platform (full size) (hwd 40 x 720 x 420)

Floor Isolation Slab (full size) (hwd 90 x 720 x 420)

hwd = (height width depth)

285.00 326.00 379.00

350.00 415.00 473.00

60.00 79.00 115.00

sound ★★★★★ build ★★★★★ verdict ★★★★★

Best Overall Support **WHAT HI-FI?** Sound Tower

Midi

Designed to fit typically: Meridian, Quad and Cyrus equipment up to 340mm wide

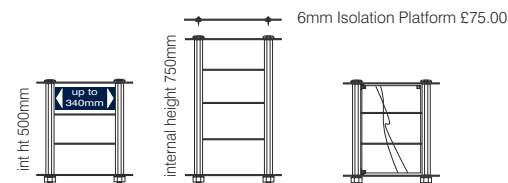

Midi Support (hwd 565 x 530 x 420)

Midi Tower (hwd 815 x 530 x 420)

Midi Support Cabinet (hwd 565 x 530 x 420)

Midi Tower Cabinet (hwd 815 x 530 x 420)

Midi Shelf (hwd 6 x 360 x 330)

Midi Isolation Platform (hwd 40 x 530 x 420)

Midi Floor Isolation Slab (hwd 90 x 530 x 420)

314.00

362.00

373.00

428.00

50.00

75.00

120.00

DVD/Blu-Ray/CD Supports

These supports offer an elegant, functional storage solution for DVDs, Blu-Ray and CD's. Supplied with brass inserts to support CDs individually or by incorporating the Metal Shelf Pack system to support the other formats. Height adjustable spikes are included to protect carpets, when ordering the stacked option a silicon buffer pack is required to correctly link the supports: £7.00. The DVD 160 is supplied with Metal Shelf Packs allowing storage of both DVDs (8 per shelf) and/or Blu-Ray (12 per shelf) cases together.

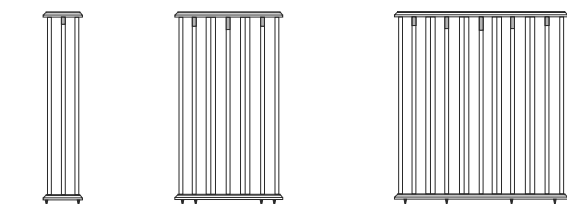

CD 60 (hwd 890 x 200 x 200)

CD 180 (hwd 890 x 540 x 240)

CD 300 (hwd 890 x 835 x 280)

DVD 160 (hwd 890 x 835 x 280)

brass inserts supplied for supporting 60 CDs

brass inserts supplied for supporting 180 CDs

brass inserts for supporting 300 CDs

20 metal shelves for 160 DVDs /240 Blu-Ray

125.00

270.00

385.00

439.00



Metal Shelf Pack

Enables storage of DVDs, CDs and Videos bookshelf fashion. A 4 pack can store at least 32 DVDs or 16 Videos. 72 CDs can be stored in a single column using 6 shelves any combination is possible giving you complete flexibility for the future. (4 shelves supplied in one pack)

25.00



Natural Cherry 6mm Sound Tower shown with Additional Shelf, Isolation Floor Slab, Isolation Platform+Flex cable management



Additional Shelf (full size) (hwd 6 x 550 x 330) Isolation Platform (full size) (hwd 40 x 720 x 420) Floor Isolation Slab (full size) (hwd 90 x 720 x 420)



Mahogany Sound Tower & Midi Isolation Floor Slab



Shelf Support Upgrade
Further enhance the sonic performance of your equipment by using these Energy Management links.

39.00



Cherry DVD160 (top) CD300+one Metal Shelf pack



Be unique!

10mm Supports

10mm clear glass structural & shelves will support 500Kg even load

10mm Cabinets

4/5mm clear or grey tint sides and doors glass options

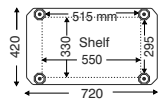

*Illustrations shown with larger Chunky Legs

10mm Isolation Platform £116.00

Standard Legs internal width 530mm

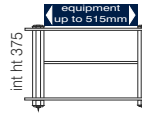

TV Support 10
(hwd 440 x 720 x 420)

Standard 45 x 45 uprights
Chunky 60 x 60 uprights

358.00 428.00

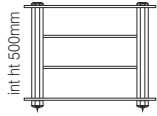

Sound Support 10
(hwd 565 x 720 x 420)

Standard 45 x 45 uprights
Chunky 60 x 60 uprights

413.00 512.00

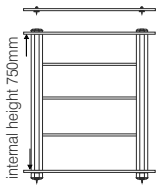

Sound Tower 10
(hwd 815 x 720 x 420)

Standard 45 x 45 uprights
Chunky 60 x 60 uprights

473.00 589.00



Quality assured
Solid kiln-dried ash hardwood

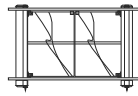

TV Support Cabinet 10

Standard 45 x 45 uprights
Chunky 60 x 60 uprights

438.00 506.00

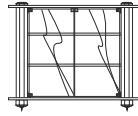

Sound Support Cabinet 10

Standard 45 x 45 uprights
Chunky 60 x 60 uprights

506.00 604.00

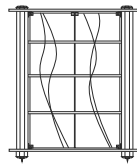

Sound Tower Cabinet 10

Standard 45 x 45 uprights
Chunky 60 x 60 uprights

589.00 714.00



Chunky Natural Ash Sound Tower 10 + additional shelf, Isolation Platform, Isolation Shelf and Floor Isolation Slab



Additional shelf 10
(hwd 10 x 550 x 330)

76.00



Isolation Platform 10
(hwd 40 x 720 x 420)

116.00



Floor Isolation Slab 10
(hwd 90 x 720 x 420)

164.00

Compact

An attractive compact solution accommodating standard full size hi-fi equipment up to 440mm
Additional Compact Shelves and Compact Isolation Platform are priced the same as 10mm Supports shown above)

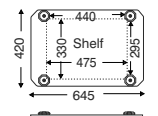

internal 455mm with std uprights

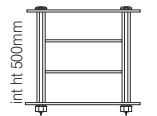

Compact TV
(hwd 440 x 645 x 420)

Standard 45 x 45 uprights
Chunky 60 x 60 uprights

358.00 428.00

Compact Sound Support
(hwd 565 x 645 x 420)

Standard 45 x 45 uprights
Chunky 60 x 60 uprights

413.00 512.00

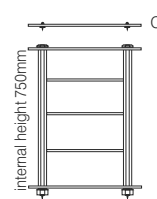

Compact Isolation Platform £116.00 option

Compact Sound Tower
(hwd 815 x 645 x 420)

Standard 45 x 45 uprights
Chunky 60 x 60 uprights

473.00 589.00

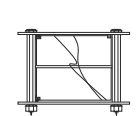

Compact TV Cabinet
(hwd 440 x 645 x 420)

Standard 45 x 45 uprights
Chunky 60 x 60 uprights

438.00 506.00

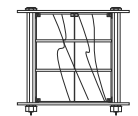

Compact Sound Support Cabinet

Standard 45 x 45 uprights
Chunky 60 x 60 uprights

506.00 604.00

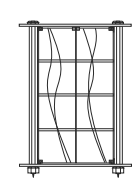

Compact Sound Tower Cabinet

Standard 45 x 45 uprights
Chunky 60 x 60 uprights

589.00 714.00

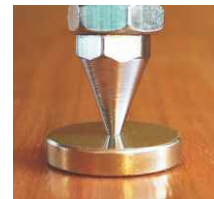

Spike Feet

Four Nickel & Brass discs to protect delicate hard floors and ensure good consistent contact for each spike.

15.00



Compact shelf
(hwd 10 x 475 x 330)

76.00



Compact Isolation Platform
(hwd 40 x 645 x 420)

116.00



Compact Floor Isolation Slab
(hwd 90 x 645 x 420)

164.00

Extended

Supports with room to spare, for all types of equipment up to the largest sizes with Chunky Uprights

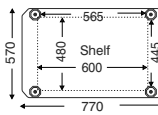

Extended Isolation Platform Option

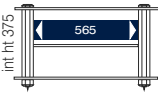

Extended TV Support
(hwd 440 x 770 x 570)

Chunky 60 x 60 uprights

549.00

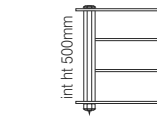

Extended Sound Support
(hwd 565 x 770 x 570)

Chunky 60 x 60 uprights

659.00

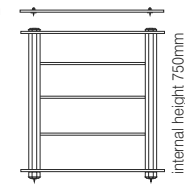

Extended Sound Tower
(hwd 815 x 770 x 570)

Chunky 60 x 60 uprights

747.00

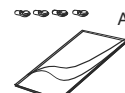

Additional Extended shelf
(hwd 10 x 600 x 480)

105.00



Extended Isolation Platform
(hwd 40 x 770 x 570)

164.00



Extended Floor Isolation Slab
(hwd 90 x 770 x 570)

219.00



Walnut Extended Sound Support shown with 24" Widescreen TV

Pure Carbon

Minimalist high performance Carbon Fibre supports

Audiophile performance - These supports will improve video and sonic performance. Sleek minimalist looks with incredible rigidity, strength and the natural beauty of carbon fibre. 10mm toughened safety glass is used from our other ranges along with pre-tensioned carbon fibre uprights and stainless steel fixings. Either system can be increased in height by adding extra standard structural glass and a set of carbon fibre uprights. Standard leg heights are offered at 135mm and 200mm. Custom heights are available, please call for details and prices for other sizes of glass, eg: Extended (770 x 570mm) and Compact (640 x 420mm).

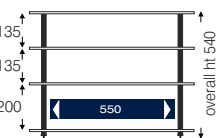

Carbon Support
(hwd 540 x 720 x 420)

Pure Carbon Fibre pre-stressed Legs

769.00

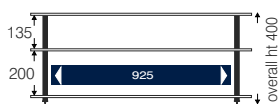

Carbon AV
(hwd 400 x 1095 x 420)

Pure Carbon Fibre pre-stressed Legs

692.00

Carbon 135
4 x CFibre Legs
135 high x 25 diameter
1x 10mm Structural Glass
720 x 420 x 10mm

176.00

Carbon 200
4 x CFibre Legs
200 high x 25 diameter
1x 10mm Structural Glass
720 x 420 x 10mm

209.00

Carbon AV 135
4 x CFibre Legs
135 high x 25 diameter
1x AV10 Structural Glass
1095 x 420 x 10mm

242.00

Carbon AV 200
4 x CFibre Legs
200 high x 25 diameter
1x AV10 Structural Glass
1095 x 420 x 10mm

275.00



Carbon AV Support

AV10

support up to 500 kilograms even load - enough room for two full size pieces of equipment side by side with no restriction on centre speaker sizes. Large Plasmas and LCD flat panels up to 64" wide can be accommodated. 10mm Toughened safety glass used throughout.



Chunky High AV10 with Natural Cherry shown with matching Stands Unique Klarity centre speaker to top shelf - see web site for details (42" Plasma).

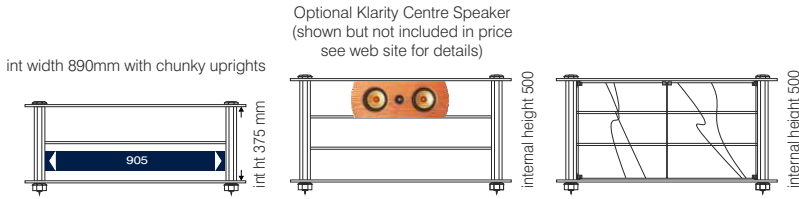

AV10

(hwd 440 x 1095 x 420)

Standard 45 x 45 uprights
Chunky 60 x 60 uprights

505.00

582.00

High AV10

(hwd 565 x 1095 x 420)

Standard 45 x 45 uprights
Chunky 60 x 60 uprights

582.00

659.00

High AV10 Cabinet

(hwd 565 x 1095 x 420)

Standard 45 x 45 uprights
Chunky 60 x 60 uprights

677.00

769.00



AV10 Shelf

(hwd 10 x 925 x 330mm)

105.00



AV10 Floor Isolation Slab

(hwd 90 x 1095 x 420)

186.00



Etched Cabinet glass shown with Chunky Natural Cherry Hardwood uprights.



Chunky AV10 + Stands Unique AVOnes on matching Reflection Supports, AVOne as centre speaker with grille cover all in Natural Ash Hardwood - see web site.

Ultimate

Visually stunning, The Ultimate range uses *Unique* shaped 10mm toughened safety glass with our solid hardwood standard or chunky sized legs. Both columns have independently adjustable shelves (25mm adjustment steps). Top cappings are replaceable with flush fittings to accommodate TV's (one is included as standard)



Solid kiln-dried ash hardwood
Quality assured

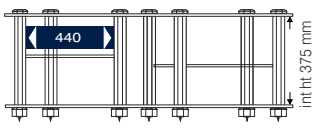

int width 455 mm std uprights

Ultimate AV Support

(hwd 440 x 1322 x 600)

Standard Uprights 45x45
Chunky Uprights 60x60

884.00

919.00

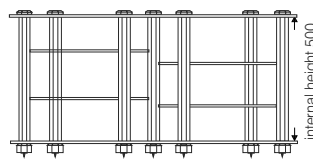

internal height 500

Ultimate High Support

(hwd 565 x 1322 x 600)

Standard Uprights 45x45
Chunky Uprights 60x60

919.00

1080.00

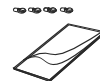

Ultimate Additional Shelf

(hwd 10 x 475 x 330mm)

76.00



Chunky Ultimate High Cabinet (grey tint) in Cherry + AV One Centre (42" Plasma)



"A stylish and flexible way of storing your AV equipment"
Ultimate High Cabinet - What Video & TV - Sept 2002

Dimensions of Ultimate shown with straight edge into a corner, typical size of a 46" Flat panel TV shown with dotted line

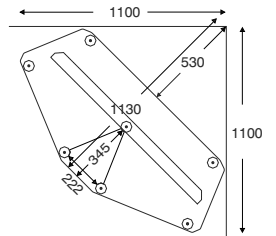

Dimensions of Ultimate shown with curved edge into a corner

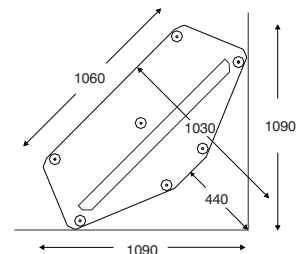

Ultimate Cabinets

Available in 4 / 5mm grey tinted or clear glass sides and doors. Cabinets offer more security from prying fingers and helps cut down dust on the equipment inside.

Optional Ultimate AV Grille cover (shown)

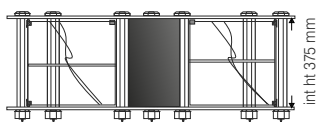

Ultimate AV Cabinet

(hwd 440 x 1322 x 600)

Standard
Chunky

942.00

1068.00

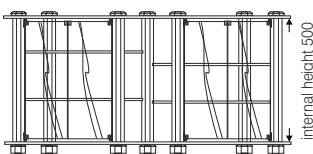

internal height 500

Ultimate High Cabinet

(hwd 565 x 1322 x 600)

Standard
Chunky

1092.00

1260.00



Ultimate AV Grille Cover
black acoustic fabric

35.00



Ultimate High Grille Cover
black acoustic fabric

45.00

Transition Wall Support



Functional and attractive. Use for a Turntable, Blu-Ray, CD /DVD Source, Midi System or LCD or Plasma Display. Solid steel 25mm diameter arms 6mm solid steel chassis

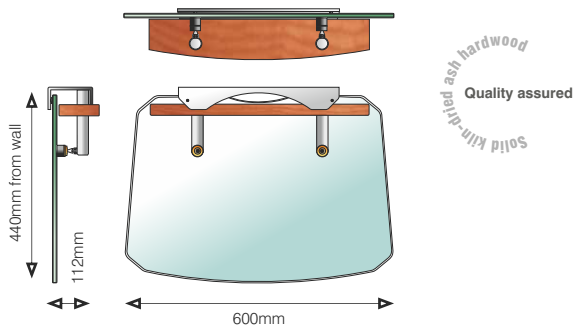

Max 35kgs recommended even load using 10mm polished toughened glass

Transition Wall Support

(hwd 112 x 600 x 440)

263.00

Optional white or blue LED Backlight



Backlight

Back light system fits inside the steel chassis. (1w LightStrips containing 12 LED's) . An attractive addition to your system which brings the Wall Support visually to life. Power Supply and 4-way block connector included with mounting clips. Available with White or Blue L.E.D light 300mm long Specify Blue or White LightStrip preference.

Backlight - 2 x LightStrip

45.00

Additional LightStrip

18.00

Cable Management Housing (hwd 1200 x 75 x 25)

A neat robust 1.2 metre upvc triple compartment box channel with removable lid. Coloured light grey to match the TWS chassis, the surface may also be painted or covered. Easily cut into sections, supplied with screw fixing kit and self adhesive hook & loop fastener dots.



"Sonically they provide a substantial boost to stereo imagery and fine detail. Musically they rock!"
Carbon Fibre Isolators Hi-Fi Choice

"Producing a tighter and more authoritative sound - which can be enhanced even more when isolators are placed between the layers of glass on which components rest, enabling you to upgrade forever."

Carbon Fibre Isolators - The Ultimate Hi-Fi & Home Cinema Guide

Energy Management



Carbon Fibre Isolators

Performance guaranteed. A set of three Carbon Fibre discs with brass spiked cones for use under any piece of equipment. They bypass the existing feet allowing the damaging energy within the equipment to be transferred and filtered through the Carbon onto a high frequency interface. They may be small but the benefits are truly remarkable. The best value sonic upgrade on the market. Highly recommended.

Overall Height 13mm

26.00

Overall Height 22mm

35.00

Isolation Shelf

Equipment platform comprising:
Compact Shelf (10 x 475 x 330mm)
1 x set of 22mm CFI
1 x set of 13mm CFI
Helps optimise any piece of hi-fi equipment on the shelf on which it resides. An instant performance upgrade

110.00

Shelf Support Upgrade

Using the same proven linking principles to actively energy manage each adjustable shelf. Set of four Carbon Discs & precision machined solid brass inserts with height adjustable lockable spikes to upgrade the standard brass inserts.

39.00

Spike Feet

Four Nickel & Brass discs to protect delicate floors and ensure good consistent contact for each spike. Perfect for hard floors.

15.00

Useful Accessories



'Flex' Cable Management

High quality 64mm diameter moulded flexible modular system 820mm high, cables simply push into place. Silver grey in colour with weighted base. See web site for more detail. Suitable to use with other manufacturers stands.

Flex

55.00



Backlight

'Lighten the atmosphere' with this latest technology L.E.D (Light emitting diode) low energy, cool running backlighting system. Power Supply with 4-way block connector and 2 x LightStrips supplied. White or Blue light 300mm long 12 x L.E.D's rated 1 watt LightStrip with polycarbonate sleeve, these can be linked together - 100,000+hr life. 2 x Shelf mounting clips supplied, simply push onto rear of glass shelf to use. Specify Blue or White LightStrip.

Backlight - 2 x LightStrip

45.00

Additional LightStrips

18.00



Kiddy Cabinet Kit

Replacement handle system for use with our cabinets where deterring little fingers from opening the doors is a priority. Separate magnetic opener is used to open the flush handles.

Kit for one pair of doors

25.00

Kit for two pairs of doors

30.00